



Operating instructions

Temperature Differential Controller

3 inputs, 1 output

These operating instructions are part of the product.

- ▶ Read these operating instructions carefully before use.
- ▶ Keep them over the entire lifetime of the product and
- ▶ pass them on to any future owner or user of this product.

US



Quick guide for end users

Safety

WARNING

Risk of death by electrocution!

- ▶ Do not open the controller case.
- ▶ Only clean the controller case using a dry cloth.



Installation, commissioning, maintenance and dismantling of the temperature differential controller may only be performed by trained professional personnel.

The operational tasks of the end user are limited to reading the temperature values and detecting faults. All other operational tasks may only be performed by trained professional personnel.

Reading temperature values

The temperature sensors measure the temperatures on the collector (T1), in the lower section of the storage tank (T2) and – if connected - in the upper section of the storage tank (T3).

The temperatures are shown on the display.

- ▶ Select temperature sensor (T1, T2, T3) using the  and  operating buttons.
- ⇒ *The selected temperature sensor and the current measured temperature are shown on the display.*

Detecting faults

- ▶ Check the display regularly.
- ▶ In case of faults, isolate the cause (see Chapter 9).

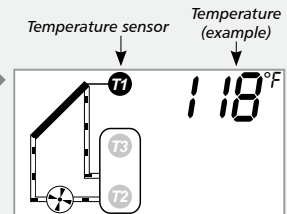
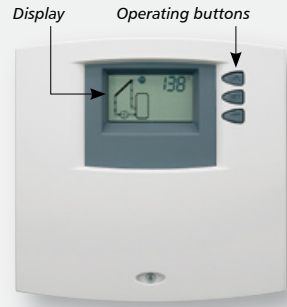

- ▶ As soon as it becomes evident that safe operation is no longer possible (e.g. visible damage), remove the device from the mains supply immediately.
- ▶ Have a trained technician remedy the fault.

Content

Quick guide for end users	2	5 Display overview	17
Safety	2	6 Commissioning	18
Reading temperature values	2	7 Description of the controller functions	19
Detecting faults	2	7.1 Automatic storage tank charging	19
1 About this manual	4	7.2 Automatic charging shutdown	19
1.1 Applicability	4	7.3 Automatic pump blockage	20
1.2 Users	4	7.4 Tube collector function	20
1.3 Description of symbols	4	7.5 Holiday function	21
2 Safety	6	7.6 Freeze recirculation function	21
2.1 Proper usage	6	8 Operation	22
2.2 Improper usage	6	8.1 Reading temperature values	22
2.3 Dangers during assembly and commissioning	6	8.2 Setting the controller	23
2.4 Exclusion of liability	8	9 Faults	26
3 Description	9	9.1 Fault causes	26
3.1 Controller in the solar circuit	9	9.2 Testing the temperature sensors	29
3.2 Case overview	10	10 Dismantling and disposal	30
4 Installation	11	11 Legal Guarantee	31
4.1 Overview of the device	11	12 Specifications	32
4.2 Opening / closing the housing	11		
4.3 Assembly	12		
4.4 Electrical connection	13		

1 About this manual

1.1 Applicability

This manual describes the installation, commissioning, function, operation, maintenance and dismantling of the temperature differential controller for solar thermal energy systems.

When installing the remaining components, e.g. the solar collectors, the pump assemblies and the storage unit, be sure to observe the appropriate installation instructions provided by each manufacturer.

1.2 Users

Installation, commissioning, operation, maintenance and dismantling of the controller may only be performed by trained professional personnel. The professional personnel must be familiar with this operation manual and follow the instructions contained herein.

The end user may only perform operating functions, which are explained in the quick guide.

1.3 Description of symbols

1.3.1 The structure of the warning notices



SIGNAL WORD

Type, source and consequences of the danger!

- ▶ Measures for avoiding danger.
-

Pictogram with corresponding warning symbol.

1.3.2 Danger levels in warning notices

Danger level	Probability of occurrence	Consequences resulting from non-compliance
 DANGER	Imminent threat of danger	Death, serious bodily injury
 WARNING	Possible threat of danger	Death, serious bodily injury
 CAUTION	Possible threat of danger	Minor bodily injury
CAUTION	Possible threat of danger	Property damage

1.3.3 Notes

Note

Notes on easier and safer working habits.

- ▶ Measures for easier and safer working habits.

1.3.4 Other symbols and markings

Symbol	Meaning
✓	Condition for action
▶	Call to action
⇒	Result of action
•	List
Emphasis on issue at hand	Emphasis on issue at hand

2 Safety

2.1 Proper usage

The temperature differential controller (below called controller) may only be used for controlling solar thermal systems within the permissible ambient conditions (see Chapter 12).

2.2 Improper usage

The controller must not be operated in the following environments:

- Outdoors
- In moist rooms or in wet areas
- In rooms where highly flammable gas mixtures can occur

2.3 Dangers during assembly and commissioning

The following dangers exist during assembly / commissioning of the controller and during operation (in case of assembly errors):

- Risk of death by electrocution
- Risk of fire due to short-circuit
- Damage to any of the constructional fire safety measures present in the building due to incorrectly installed cables
- Damage to the controller and connected devices due to improper ambient conditions, inappropriate power supply and connecting prohibited devices

Therefore, all safety regulations apply when working on the mains supply. Only licensed contractors as per state and local electrical codes may perform work that requires opening the controller (such as connecting or replacing the fuse).

- ▶ When laying cables, ensure that no damage occurs to any

of the constructional fire safety measures present in the building.

- ▶ Make sure that the permissible ambient conditions at the installation site – in particular, the specified protection class – are not exceeded (see Chapter 12).
- ▶ Factory labels and markings may not be altered, removed or rendered unreadable.
- ▶ Before connecting the device, make sure that the electrical power supply matches the electrical specifications on the type plate. These are indicated on the specification label on the exterior of the controller.
- ▶ Make sure that all devices which are connected to the controller conform to the technical specifications of the controller.
- ▶ Secure the device against unintentional start-up.
- ▶ All work on an open controller must be performed with the controller disconnected from the AC power supply.
- ▶ Protect the controller against overloading and short-circuiting.

2.4 Exclusion of liability

The manufacturer cannot monitor the compliance to this manual as well as the conditions and methods during the installation, operation, usage and maintenance of the system controller. Improper installation of the system may result in damage to property and, as a result, to bodily injury. The installer must comply with all national, state and local codes which cover the use of these controllers by licensed contractors.

Therefore, we assume no responsibility and liability for loss, damage or costs which result from or are in any way related to incorrect installation, improper operation and incorrect usage and maintenance.

Similarly, we assume no responsibility for patent right or other right infringements of third parties caused by usage of this system controller.

The manufacturer reserves the right to make changes to the product, technical data or assembly and operating instructions without prior notice.

- ▶ As soon as it becomes evident that safe operation is no longer possible (e.g. visible damage), disconnect the device from the electrical power supply immediately.

3 Description

3.1 Controller in the solar circuit

3.1.1 The purpose of the controller

The controller controls the solar thermal system

3.1.2 The structure of the solar circuit

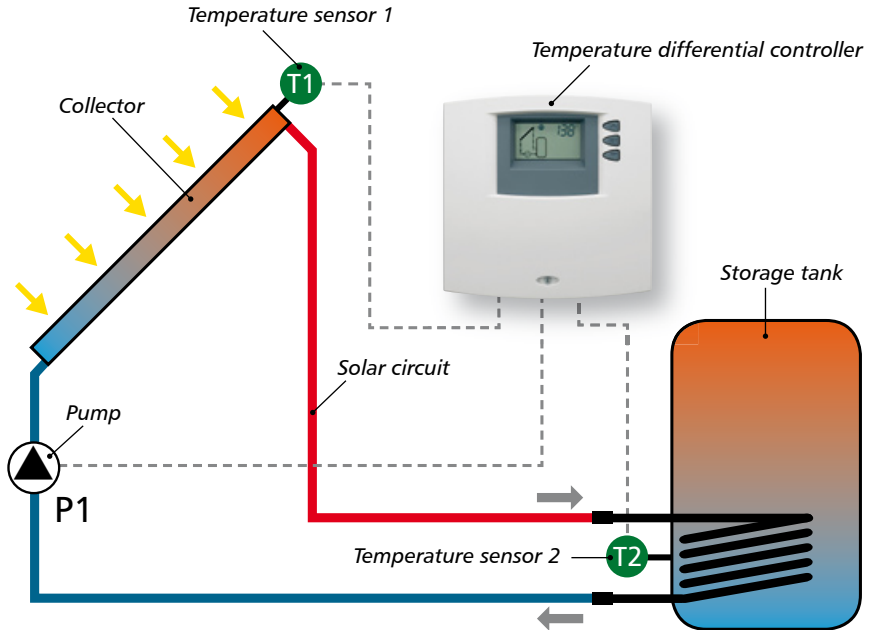

3.1.3 The function of the solar circuit

The controller constantly measures the temperatures of the collector (T1) and the lower area of the storage tank (T2) via PT1000 temperature sensors. The controller switches the pump on or off depending upon the absolute temperature at T1 and T2, or the differential temperatures between T1 and T2. T3 is for informational purposes only.

The pump extracts the heat transfer fluid from the lower cooler area of the storage tank and pumps it to the collector. The heat transfer fluid in the collector is heated by the sun and flows back to the storage tank.

The heat transfer fluid heats the domestic water via a heat exchanger located in the storage tank.

3.2 Case overview

Operating switch

The following modes of operation can be switched:

- On
for commissioning
and testing for function
- Auto
for normal operation
- Off
for switch-off the
pump

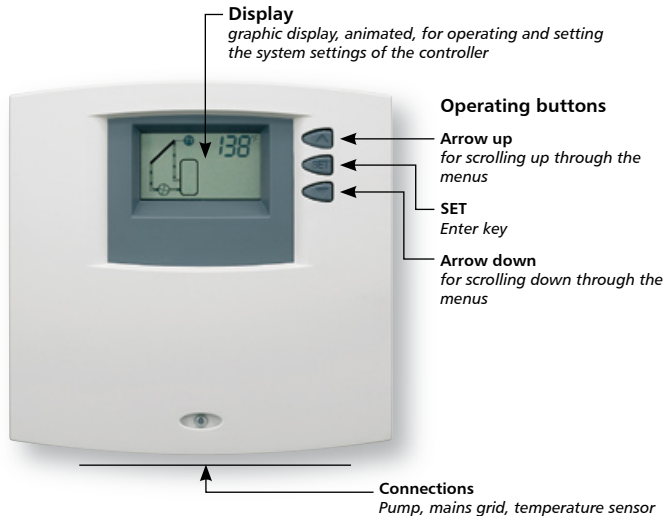
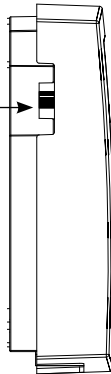



4 Installation

⚠ WARNING

Risk of electric shock caused by unintentional start-up!

- ▶ Make sure that the power supply cannot be unintentionally switched on.

4.1 Overview of the device

Prefabricated; with mains connection cable and pump socket

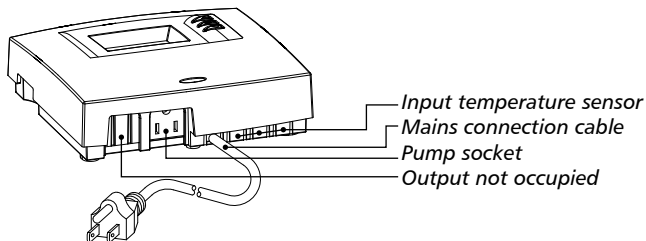

4.2 Opening / closing the housing

⚠ WARNING

Risk of death by electrocution!

- ▶ Remove the controller from the power supply before opening the case.
- ▶ Make sure that the power supply cannot be unintentionally switched on.
- ▶ Do not damage the case.



-
- ▶ Only switch the power supply back on after the case has been closed.
-

The top of the case is retained by two retaining pegs on the upper edge of the lower half of the case and fastened with a screw.

4.2.1 Opening the case

- ▶ Loosen the screw and remove the upper case in an upwards direction.

4.2.2 Closing the case

- ▶ Position the upper case at an angle to the lower case. Insert the hinge grooves into the retaining pegs of the lower case.
- ▶ Pivot the upper case down and feed the operating buttons through the matching holes.
- ▶ Fasten the case tightly with the screw.

4.3 Assembly

WARNING

Risk of electric shock and fire if assembled in a moist environment!

- ▶ Only assemble the controller in an area where the protection class is sufficient.
-

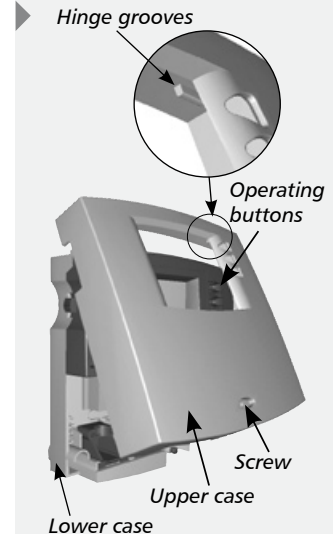

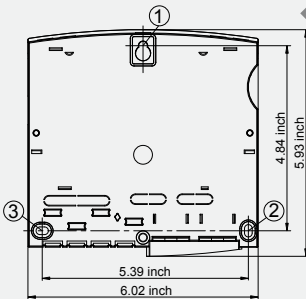

4.3.1 Assembling the controller

CAUTION

Risk of injury and damage to the case when drilling!

- ▶ Do not use the case as a drilling template.

- ▶ Choose a suitable installation site.
- ▶ Drill the upper fastening hole.
- ▶ Screw in the screw.
- ▶ Remove the upper case.
- ▶ Hang the case in the recess①.
- ▶ Mark the position of the lower fastening holes ②,③.
- ▶ Remove the case again.
- ▶ Drill the lower fastening holes.
- ▶ Re-hang the case in the recess①.
- ▶ Screw the case firmly using the lower fastening holes ② and ③. Do not overtighten the screws as this may cause damage to the case.
- ▶ Mount the upper case.

4.4 Electrical connection

WARNING

Risk of death by electrocution!

- ▶ Disconnect the controller from the electrical power supply before opening the case.
- ▶ Observe all guidelines and regulations of the local electricity supplier.

4.4.1 Preparing the cable feed

Depending on the type of installation, the cables may enter the device through the rear of the case or the lower side of the case.

Feeding the cable through the rear of the case ⑦:

WARNING

Risk of electrical shock and fire due to cables coming loose!

- ▶ Install an external strain relief for the cables.
-
- ▶ Remove the plastic flaps ⑦ from the rear side of the case using an appropriate tool.

Feeding the cable through the lower side of the case ⑥:

WARNING

Risk of electrical shock and fire due to cables coming loose!

- ▶ Fasten the flexible cabling to the case using the strain-relief clamps provided.

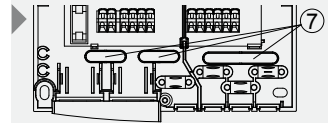

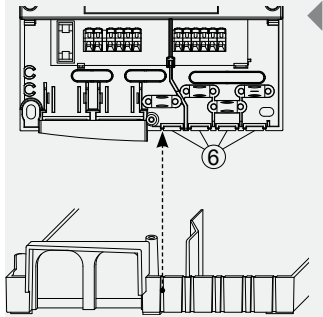

- ▶ Cut the left and right plastic flaps ⑥ using an appropriate tool (e.g. knife) and carefully remove them from the case.

4.4.2 Connecting the cables

- ▶ If a protective conductor is provided or required for the pump, connect the protective conductor to the terminal clamps of the controller. When connecting the protective conductor, observe the following points:
 - Make sure that the grounding contact is also connected to the controller's mains supply side.
 - Each terminal may only be connected to a single connecting wire (max #AWG 14).
 - Fine core cables should use wire end sleeves (ferrules).
- ▶ Only use the original temperature sensors (Pt1000) that are approved for use with the controller.
- ▶ To avoid inductive effects, observe the following points:
 - The polarity of the sensor contacts is not important.
 - Do not lay sensor cables close to 120 VAC or 240 VAC cables (minimum separation of 3.94 inch).
 - If inductive effects are expected, e.g. from heavy current cables, overhead train cables, transformer substations, radio and television devices, amateur radio stations, microwave devices etc. , then the sensor cables must be adequately shielded.
- ▶ Sensor cables may be extended to a maximum length of ca. 330 ft. When using extension cables, select the following cable cross sections:
 - #AWG 18 up to 165 ft long
 - #AWG 14 up to 330 ft long
- ▶ Connect the cables in accordance with the terminal plan (see Chapter 4.4.3 or 4.4.4).

4.4.3 Terminal plan 120 V version

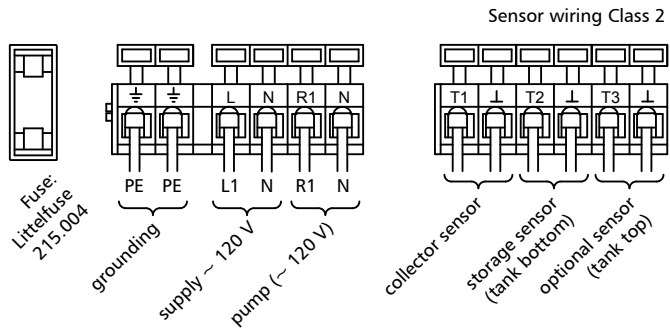

Look at the product label for the version

5 Display overview

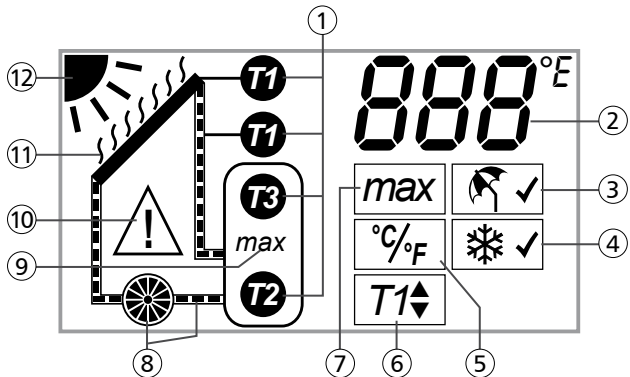

- ① Temperature sensor symbols
- ② Displays the temperature values and faults, e. g. short circuit, interruption (see p. 27) or SYS = system error (see p. 28)
- ③ Holiday function (see p. 21)
- ④ Freeze recirculation function (see p. 21)
- ⑤ Selecting the temperature unit °C / °F
- ⑥ Tube collector function (see p. 20)
- ⑦ Setting the maximum storage tank temperature
- ⑧ Solar circuit symbols
- ⑨ Indication that tank maximum temperature has been reached.
- ⑩ Warning display if faults occur, e. g. short circuit, interruption (see p. 27) or SYS = system error (see p. 28)
- ⑪ Indication that collector fluid may have reached boiling point.
- ⑫ Indication that sufficient solar energy is available to heat water.

6 Commissioning

6.1 Testing the pump

CAUTION

Damage to pump caused by drawing in air!

- ▶ Make sure that the solar circuit is filled with collector fluid.

- ✓ The controller case is closed
- ✓ The solar energy system is filled
- ▶ Connect the mains supply.
- ▶ To switch on the pump, set the operating switch to the upper position.
 - ⇒ *The display is lit with a red background.*
 - ⇒ **On** appears in the display. After approx. 3 seconds **on** begins to flash.
- ▶ To switch off the pump, set the operating switch to the lower position.
 - ⇒ *The display is lit with a red background.*
 - ⇒ **Off** appears in the display. After approx. 3 seconds **off** begins to flash.

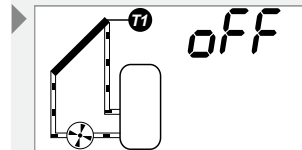
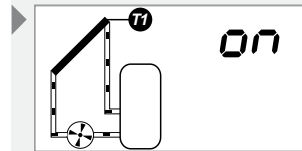
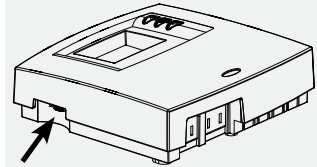
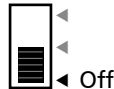

CAUTION

The incorrect operating mode may cause the system to shut down or impair proper functioning!

- ▶ After testing the pump, set the operating switch to automatic operation.



- ▶ To set the controller in automatic operation, set the operating switch to the middle position.
 - ⇒ *The display is lit with a yellow background.*
 - ⇒ **Aut** is shown in the display for approx. 3 seconds.

7 Description of the controller functions

7.1 Automatic storage tank charging

The controller constantly compares the temperatures between the collector (T1) and the lower area of the storage tank (T2). As soon as the temperature in the collector (T1) is 16 diff. °F (constant fixed value) higher than the temperature in the storage tank (T2), the following display appears:

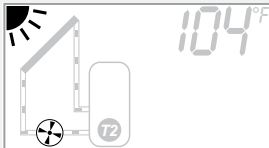

- The sun symbol is displayed
- If no safety limits prohibit the pump from operating, the pump is switched on. The following display appears:

- The pump symbol rotates

If the temperature difference falls below 8 diff.°F (constant fixed value), the pump is switched off. The sun symbol is no longer shown in the display.

7.2 Automatic charging shutdown

If the lower area of the storage tank (T2) reaches the set maximum storage tank temperature (factory setting of 140 °F), charging is stopped. A temperature of 6 diff. °F below the maximum storage tank temperature must first be reached before charging can be resumed.

The following displays appear:

- The pump symbol does not move
- The sun symbol is displayed
- The **max** indication flashes in the storage tank symbol

7.3 Automatic pump blockage

During time periods of high solar irradiance, the temperature (T1) of the heat transfer fluid can exceed 266 °F. The heat transfer fluid reaches boiling point. In this case, the pump is blocked for protection purposes until the temperature drops below 261 °F.

The following displays appear:

- The pump symbol does not move
- The sun symbol is displayed
- The vapor symbol flashes

7.4 Tube collector function

Due the design of many vacuum tube collectors, it is not possible to directly measure the temperature of the collector. Many vacuum tube collectors do not have immersion sensors or any direct thermal connection between the outlet pipes and the collector tubes. It may only be possible to measure the temperature output of the collector when the heat transfer fluid is flowing. In these cases, the solar circuit must be briefly activated at regular intervals to transmit the actual heat from the collector pipe to the sensor (T1). If the tube collector function is activated, the controller automatically switches the pump on every 30 minutes for 30 seconds.

The following displays appear:

- The tube collector function shows T1 in the lower position

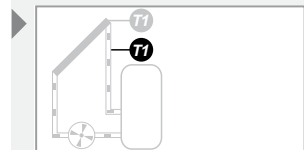
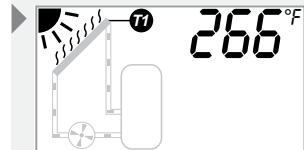
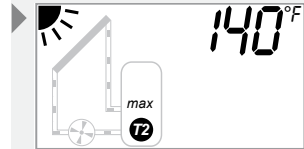

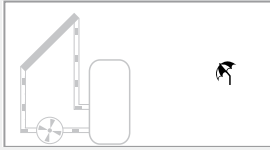

7.5 Holiday function

The holiday function is used to cool down the water in the storage tank by pumping heat transfer fluid through the collector when the collector is cooler than the tank, (usually at night). During periods with little or no hot water use and intense solar heat, such as during vacations, the tank will be at maximum temperature and the solar system will be subjected to high thermal loads and possible boiling of the heat transfer fluid.

When the holiday function is activated, the controller will attempt to cool the storage tank by running the pump as follows: The pump is activated IF the tank temperature approaches 20°F of the maximum tank temperature ($\text{MaxTank} - T_2 < 20^{\circ}\text{F}$) AND the collector is 16°F cooler than the tank ($T_2 - T_1 > 16^{\circ}\text{F}$). The pump will then remain running until EITHER the tank temperature cools down to 95°F ($T_2 < 95^{\circ}\text{F}$) OR the collector temperature approaches 8°F of the tank temperature ($T_2 - T_1 < 8^{\circ}\text{F}$).

For example, if max tank is set at 140°F , the holiday function will attempt to cool down the tank once T_2 reaches 120°F and will stop once T_2 falls to 95°F . The pump will only operate once the collector temperature falls to 16°F cooler than the tank and will be switched off once the collector is only 8°F cooler than the tank.

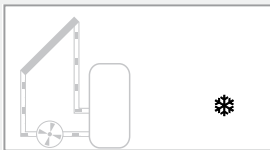

7.6 Freeze recirculation function

If the freeze recirculation function is activated, the controller switches the pump on as soon as the collector temperature falls below $+41^{\circ}\text{F}$. The heat transfer fluid is thus pumped through the collector and the system is prevented from freezing. If the collector reaches $+45^{\circ}\text{F}$, the pump is switched off.

Despite the freeze recirculation function being activated, the solar system can freeze under the following conditions:

- In a power outage.
- If frost is expected for a long-term period of time.

Therefore, solar systems exposed to frost for an extended period of time should only be operated with anti-freeze.

8 Operation

CAUTION



The incorrect operating mode may cause the system to shut down or impair proper functioning!

- ▶ Make sure that the operating switch is set to automatic operation.

8.1 Reading temperature values

NOTE

The temperature in the above storage tank is only displayed if the temperature sensor T3 (not included) is also connected.

- ▶ Select temperature sensor (T1, T2, T3) using the  and  buttons.
- ⇒ *The selected temperature sensor and the current measured temperature appear in the display.*

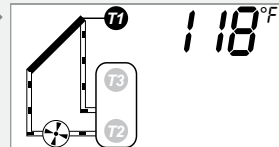

8.2 Setting the controller

8.2.1 Menu operation

- ▶ To open the menu settings, press the **SET** button for approx. 2 seconds.
 - ⇒ *The current storage tank maximum temperature is displayed.*
 - ⇒ *Symbol for the T2 temperature sensor and max flash.*
- ▶ To switch to the next setting, press the **▲** or **▼** button.
- ▶ To exit the menu settings, press the **▼** button again until the menu display is no longer displayed.

8.2.2 Setting the storage tank maximum temperature

CAUTION

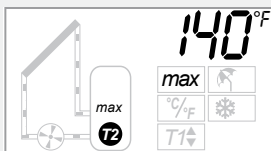

Risk of scalding by excessive domestic water temperature!

- ▶ Set the storage tank maximum temperature to maximum 140 °F.
- ▶ Install a thermostatic mixer in the hot water pipe and set to maximum 140 °F.



- ✓ The menu is open
- ▶ Press the **SET** button for approx. 2 seconds until the storage tank maximum temperature flashes.
- ▶ Change the storage tank maximum temperature using the **▲** or **▼** buttons.
- ▶ To save the value, press the **SET** button.

8.2.3 Selecting the temperature unit

- ✓ The menu is open
- ▶ Press the  button again until °C / °F flashes.
- ▶ Press the  button for approx. 2 seconds until the desired temperature unit – °C or °F – flashes.

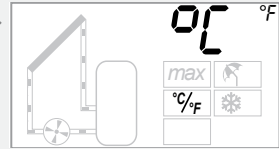



8.2.4 Activating the tube collector function

NOTE

Incorrectly setting the controller can compromise the efficiency of the solar energy system.

- ▶ Only activate the tube collector function with vacuum tube collectors.

- ✓ The menu is open
- ▶ Press the  button again until the symbol for T1 flashes.
- ▶ Press the  button for approx. 2 seconds until the symbol for T1 switches from the upper to the lower position.

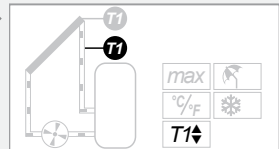



8.2.5 Activating/deactivating the holiday function

NOTE

Incorrectly setting the controller compromises the efficiency of the solar energy system.

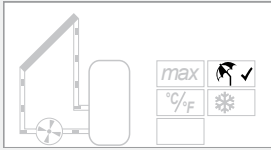
- ▶ Only activate the holiday function when you intend to be absent for an extended period.
- ▶ Deactivate it again after having returned.



- ✓ The menu is open
- ▶ Press the  button until the holiday symbol flashes.
- ▶ Press the  button for approx. 2 seconds until the small tick on the holiday symbol appears/goes out.

8.2.6 Activating/deactivating the freeze recirculation function

CAUTION

System can freeze despite the activated freeze recirculation function

During a power outage, the freeze recirculation function does not operate.

During long-term time periods of frost, the system can freeze despite the freeze recirculation function.



- ▶ If frost is expected for a long-term period of time, only operate the system with anti-freeze.

NOTE

Incorrectly setting the controller can compromise the efficiency of the solar energy system.

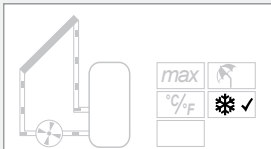
- ▶ Only activate the freeze recirculation function for solar energy systems that are not filled with anti-freeze.



- ✓ The menu is open
- ▶ Press the  button again until the freeze recirculation symbol flashes.
- ▶ Press the  button for approx. 2 seconds until the small tick on the freeze recirculation symbol appears/goes out.

9 Faults

The controller is designed for years of continuous trouble-free operation. Nevertheless, faults may occur. In most cases, the fault, however, does not lie with the controller, but rather with the peripheral components. The following description covers the most common problems encountered with the controller.

- ▶ Only send in the controller if none of the following faults are present.

9.1 Fault causes

WARNING

Risk of death by electrocution!

- ▶ Remove the controller from the power supply before opening the case.

Controller does not appear to function at all

Secondary symptoms	Possible cause / remedy
The controller display is blank.	No power supply present <ul style="list-style-type: none"> ▶ Have a specialist check the fuse and the supply cable.



The pump, which is connected to the controller, is not running although its switch-on conditions have been fulfilled (sun symbol in display)

Secondary symptoms	Possible cause / remedy
The pump symbol rotates in the display.	The pump connecting cable is not connected, interrupted or the fuse in the controller is burned out. ► If necessary, have a specialist replace the fuse. Only use Littelfuse 215.004 fuses. (Replacement fuse is located in the case).
<ul style="list-style-type: none"> • The pump symbol does not rotate • Display is lit with a red background • OFF flashes 	Operating switch is set to manual ► Set the operating switch to automatic operation.

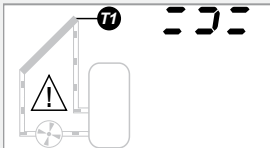

Short-circuit symbol and warning display appear

Secondary symptoms	Possible cause / remedy
<ul style="list-style-type: none"> • The pump symbol does not rotate • Display background alternately flashes red and yellow • Pump is short-circuited 	Temperature sensor or its supply cable short-circuited ► Have a specialist check the supply cables of the temperature sensors and that they are correctly connected to the controller.

NOTE

In case of T3 short-circuits, the pump does not stop.

Interruption symbol and warning signal appear

Secondary symptoms	Possible cause / remedy
<ul style="list-style-type: none"> The pump symbol does not rotate Display background alternately flashes red and yellow Sun symbol goes out 	<p>Temperature sensor T1 or T2 or its supply cable is interrupted</p> <p>Note: No message appears for T3</p> <ul style="list-style-type: none"> ▶ Have a specialist check the supply cables of the temperature sensors and that they are correctly connected to the controller.

NOTE

If T3 is interrupted, no message appears.

SYS flashes in the controller display

Possible cause / remedy
<p>SYS means there is a system error. This means that despite the pump running, a temperature difference exceeding 160 diff. °F between the collector and the storage tank was recorded.</p> <p>The following causes are possible:</p> <ul style="list-style-type: none"> The pump is faulty or not correctly connected The isolating valve in the solar circuit is still closed Air is in the solar circuit <p>Since a standard circulation pump cannot eliminate air bubbles inside the piping system, the heat transfer medium circuit comes to a standstill.</p> <ul style="list-style-type: none"> ▶ Have a specialist check the solar energy system to prevent damage. ▶ Once the fault has been remedied, press any button to acknowledge the fault message.

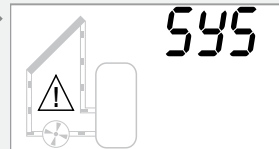
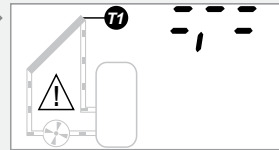

9.2 Testing the temperature sensors

9.2.1 Safety

Only trained personnel may test the temperature sensors.

9.2.2 Testing the resistance values



⚠ WARNING

Risk of death by electrocution!

- ▶ Disconnect the controller from the electrical power supply before opening the case.
-

The temperature is recorded by resistance sensors. These are PT1000 temperature sensors. Depending on the temperature, the resistance value also changes. A potentially defective sensor can be checked using an ohmmeter.

Measuring resistance values

- ▶ Disconnect the corresponding temperature sensor from the controller.
- ▶ Measure the resistance value. The typical resistance values, depending on the temperature, are listed in the following table. Please observe that small deviations are acceptable.

Temperature sensor resistance values						
Temperature [°F]	-22	-4	-14	32	50	68
Temperature [°C]	-30	-20	-10	0	10	20
Resistance [Ω]	882	922	961	1000	1039	1078
Temperature [°F]	86	104	122	140	158	176
Temperature [°C]	30	40	50	60	70	80
Resistance [Ω]	1117	1155	1194	1232	1271	1309
Temperature [°F]	194	212	230	248	266	284
Temperature [°C]	90	100	110	120	130	140
Resistance [Ω]	1347	1385	1423	1461	1498	1536
Temperature [°F]	302	320	338	356		
Temperature [°C]	150	160	170	180		
Resistance [Ω]	1573	1611	1648	1685		

10 Dismantling and disposal

WARNING

Risk of death by electrocution!

- ▶ Remove the controller from the power supply before dismantling the controller.
- ▶ To dismantle the controller, follow the assembly instructions in the reverse order.
- ▶ Dispose of the controller in accordance with the regional regulations.
- ▶



11 Legal Guarantee

In accordance with German statutory regulations, there is a 2-year legal guarantee on this product for the customer.

The seller will remove all manufacturing and material faults that occur in the product during the legal guarantee period and affect the correct functioning of the product. Natural wear and tear does not constitute a malfunction. Legal guarantee does not apply if the fault can be attributed to third parties, unprofessional installation or commissioning, incorrect or negligent handling, improper transport, excessive loading, use of improper equipment, faulty construction work, unsuitable construction location or improper operation or use. Legal guarantee claims shall only be accepted if notification of the fault is provided immediately after it is discovered. Legal guarantee claims are to be directed to the seller.

The seller must be informed before legal guarantee claims are processed. For processing a legal guarantee claim an exact fault description and the invoice / delivery note must be provided.

The seller can choose to fulfil the legal guarantee either by repair or replacement. If the product can neither be repaired nor replaced, or if this does not occur within a suitable period in spite of the specification of an extension period in writing by the customer, the reduction in value caused by the fault shall be replaced, or, if this is not sufficient taking the interests of the end customer into consideration, the contract is cancelled.

Any further claims against the seller based on this legal guarantee obligation, in particular claims for damages due to lost profit, loss-of-use or indirect damages are excluded, unless liability is obligatory by German law.

12 Specifications

Temperature differential controller	
Operating voltage	120 VAC ($\pm 15\%$), 60 Hz [optional 240 VAC ($\pm 15\%$), 60 Hz]
Controller's own consumption	≤ 1 Watt
3 inputs for temperature recording	Pt1000
1 output	Switch relay; Switching performance max. 0.5 HP (120 VAC); 1 HP (240 VAC) Fuse: Littelfuse 215.004
Display	Animated LCD display, 2-colour background
Protection class	IP 20/DIN 40050
Permitted ambient temperature	32 °F to 113 °F (0 °C to +45 °C)
Assembly	Wall-mounted
Weight	19.54 oz (0.55 kg) include cable
Case	Recyclable 3-piece plastic case
Dimensions	6.3"(W) x 6.18"(H) x 1.85"(D) 160 mm x 157 mm x 47 mm (L x B x H)
Temperature sensors 2x Pt1000	Collector sensor: 4.9 ft silicone cable with bushing (Temperature limit 356 °F (+180 °C)) Storage tank sensor: 0.9 ft twisted single conductor flat surface sensors with compression cable lug (Temperature limit 221 °F (+105 °C))



717025